



BOWFLEX[®]

SelectTech[®]

**1090 DUMBBELLS
Owner's Manual**

Model: BD1090



Preface

Congratulations on the your purchase of the Bowflex® SelectTech® Dumbbell set. This innovative dumbbell is a versatile training tool that will help you reach your fitness goal. This product has been carefully engineered and manufactured to provide a wide array of weight options starting at 10 lbs and going all the way up to 90 lbs. In order to utilize this product to its fullest extent, it is critical that you read and fully understand this owner's manual prior to using the SelectTech® dumbbell.

To validate warranty support, keep the original proof of purchase and record the following information:

Serial Number _____ **Serial Number** _____

Date of Purchase _____

To register your product warranty, go to: www.bowflex.com/register
or call 1 (800) 605-3369.

If you have questions or problems with your product, please call 1 (800) 605-3369.

Table of Contents

Important Safety Instructions	1	Arm Exercises	23
Safety Warning Labels and Serial Number	2	Standing curls	23
Product Specifications	2	Concentration curls	23
SelectTech® Operation	3	Incline bench curls.....	24
Getting to know your Bowflex®		Scott curls - standing	
SelectTech® Dumbbells	3	concentration curls	24
Understanding and testing locking		Overhead triceps extension	25
mechanism function	4	Triceps kickback	25
Function	4	Lying triceps extension	26
Purpose	4	Hammer curls	26
Testing proper locking mechanism		Back Exercises	27
function.....	4	Single arm row - alternating rows	27
Offset weight selection	5	Wide rows	27
Example of offset weight selection.....	5	Dead lifts	28
Weight setting charts.....	6	Abdominal Exercises	29
Maintenance.....	7	Ab crunch.....	29
Dumbbell stand.....	8	Reverse crunch	29
Troubleshooting guide.....	9	Lying trunk rotation.....	30
SelectTech® 6 week Challenge	10	Twisting side crunch	30
SelectTech® Menu Plan	14	Lying leg raise	31
Leg Exercises	17	Shoulder Exercises	32
Wide squats	17	Standing shoulder press.....	32
Calf raises	17	Lateral raise	32
Stationary lunges	18	Seated overhead press.....	33
Stiff-leg dead lift.....	18	Front raise	33
Reverse lunge.....	19	Rear delt row	34
Chest Exercises	20	Shrugs.....	34
Flat chest press	20	Muscle Chart	35
Incline chest press	20		
Flat chest fly.....	21		
Incline chest fly	21		
Decline chest fly	22		

Important Safety Instructions

 This icon means a potentially hazardous situation which, if not avoided, could result in death or serious injury.

Before using this equipment, obey the following warnings:

 Read and understand the complete Owner's Manual. Keep Owner's Manual for future reference.

Read and understand all Warnings on this machine. If at any time the Warning stickers become loose, unreadable or dislodged, contact Nautilus® Customer Service for replacement stickers.

- Children must not be let on or near to this machine. Moving parts and other features of the machine can be dangerous to children.
- Not intended for use by anyone under 14 years of age.
- Consult a physician before starting an exercise program. Stop exercising if you feel pain or tightness in your chest, become short of breath, or feel faint. Contact your doctor before using the machine again.
- This machine is for home use only.
- Periodically inspect and test the locking mechanism for correct function. Follow the test procedures included in this manual.
- Do not operate this machine outdoors or in moist or wet locations.
- Before you start your workout, make sure that your surroundings are free from possible interference and third parties.
- Do not over exert yourself during exercise. Operate the machine in the manner described in this manual.
- Do not try to force the Adjustment Knob to turn when the Dumbbell has been removed from the Dumbbell base.
- Do not let the Dumbbells fall freely to the ground. Damage to the product and possible personal injury can occur.
- Do not let the Dumbbells forcefully hit together during operation. Damage to the product and possible personal injury can occur.
- Do not lean on the Dumbbell handles or use them to support your body weight, such as using them as a base to perform a push up. Damage to the product and possible personal injury can occur.
- Do not try to disassemble your Dumbbell handles, or base assembly. The product is not designed to be serviced by the customer. Contact Nautilus® Customer Service for repair information.
- The Dumbbells are very heavy. If you are not using the optional Dumbbell Stand, put the Dumbbell assembly directly on the floor for best support.

Nautilus, Inc., (800) NAUTILUS / (800) 628-8458, www.NautilusInc.com - Customer Service: North America (800) 605-3369, csnls@nautilus.com | outside U.S. +01-360-859-5180, technics-APLA@nautilus.com |

Printed in China | © 2006 Nautilus, Inc., All rights reserved.™ and ® indicate a trademark or registered trademark. Nautilus, Inc. (www.NautilusInc.com) trademarks include NAUTILUS®, BOWFLEX®, SCHWINN® and UNIVERSAL® and respective logos. Other trademarks are the property of their respective owners.

Safety Warning Labels and Serial Number

Record serial number in the Serial Number field at the beginning of this manual.

Note: Each dumbbell base has a unique serial number.

WARNING

Do not allow Children to use this product. Inspect product before use. Do not use if any parts are in need of repair. Use Caution when using this equipment. Injury or death is possible if Caution is not used. Read and understand the Owners Manual prior to use. Replace this or other CAUTION, WARNING, or DANGER Labels if they become damaged or illegible or removed. This product is for Residential use only.

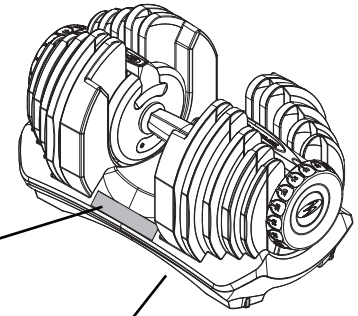

Serial number

Product Specifications

DIMENSIONS:

17.5" L x 9.5" W x 10" H
(44.4 cm x 24.2 cm x 25.3 cm)

ASSEMBLED UNIT WEIGHT:

98 lbs (44.5 kg)

SHIPPING PACKAGE WEIGHT:

105 lbs (47.6 kg)

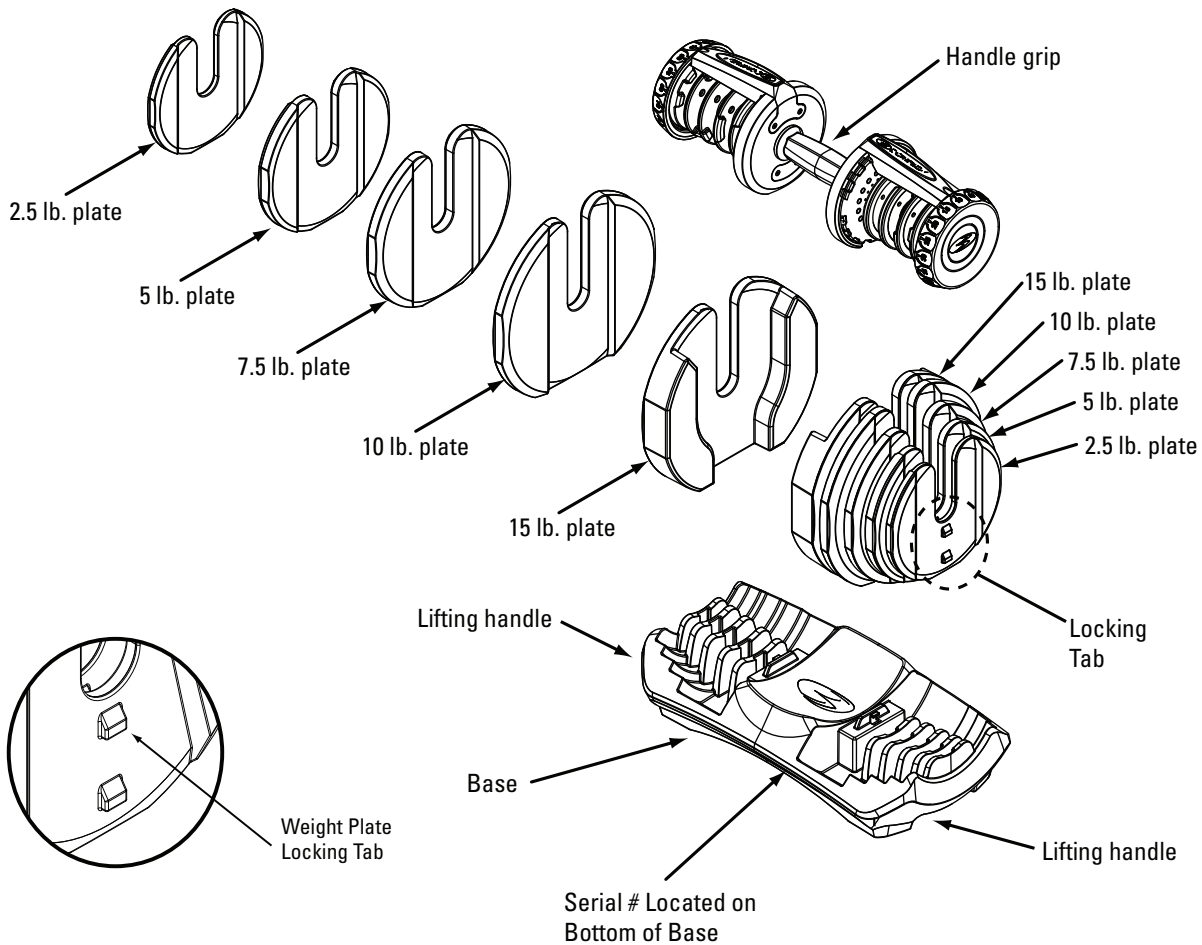
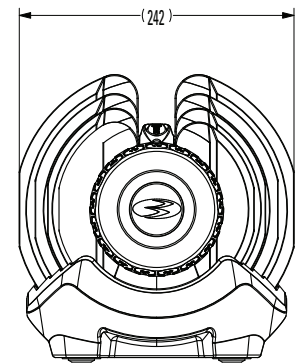
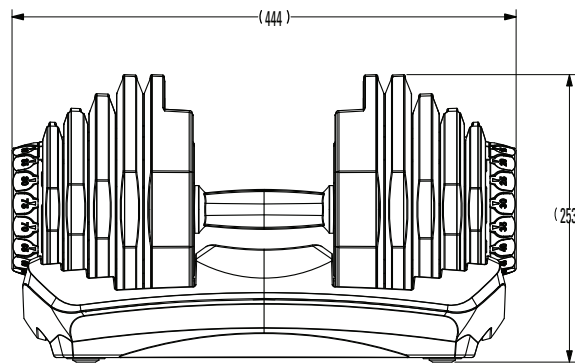

Getting to know your Bowflex® SelectTech® Dumbbells

The Bowflex® SelectTech® dumbbells are shipped fully assembled, one dumbbell to a box. After carefully removing the dumbbell from its box, there are some initial steps that should be taken to familiarize you with the function of the product and to assure that all aspects of the dumbbell are performing according to their specifications.

! Do not drop the dumbbell. Dropping the dumbbell will damage the weight plates and/or the locking mechanism, and can cause the weight plates to disengage (drop) from the handle without warning. This can cause serious injury, and will void the warranty.

1. After removing the dumbbell from its protective packaging, push down slightly on the handle assembly to make sure it is fully depressed into the base.
2. Rotate each adjustment knob several full rotations to make sure it is turning freely—do this in both directions. Make sure there is a click at each weight increment of the adjustment knob. This click will help you locate the proper alignment to select a given weight increment.

3. You will notice that there are weight increments from 10 to 90 lbs on both adjustment knobs. To properly select a given weight (20 lbs for example), both adjustment knobs should be rotated until 20 is aligned with the arrow located on the outward edge of the Bowflex® nameplate (Fig.1).



Figure 1

4. After confirming the proper rotational function of the adjustment knob, turn each adjustment so that the number 10 is aligned with the arrow in the Bowflex® nameplate.

5. With both adjustment knobs set to 10, pull the handle straight up from the dumbbell. This will remove just the handle from the base, leaving all of the weight plates standing in the base (Fig. 2.). The handle without plates represents the starting weight of 10 lbs.



Figure 2

552 model demonstrated.
1090 model has chrome handles.

6. You may increase the selected weight by rotating each adjustment knob clockwise.

7. The dumbbell handle and weight plates are symmetrical. This means that one may insert the handle with either end facing the user provided that you have selected the same weight number on both ends of the dumbbell.

NOTICE: When you remove the dumbbell from the base or return it to the base, use a vertical motion, perpendicular to the base. Do not tilt the dumbbell or move it laterally (parallel to the base) until it is fully clear of the unselected weight plates.

! Do not lean on the dumbbell handles or use them to support your body weight, such as using them as a base to perform a push up. Doing so will damage the weight plates and/or the locking mechanisms, and can cause the weight plates to disengage (drop) from the handle without warning. This can cause serious injury, and will void the warranty.

! Inspect the dumbbells prior to each use. Do not use a dumbbell with worn or damaged parts. Contact Nautilus® Customer Service for repair information.

Weight will increment in the following 17 steps:

1090 Dumbbell Weight Selection Increments
10
15
20
25
30
35
40
45
50
55
60
65
70
75
80
85
90

Understanding and testing the locking mechanism function

The Bowflex® SelectTech® Dumbbell features a patent pending locking mechanism designed to assure proper and complete selection of the weight plates as well as to ensure weight plate retention during the workout.

- ⚠ Fully understand the function of this mechanism and do tests of the mechanism regularly to make sure it operates correctly.

Function

The locking mechanism provides two key functions:

1. The mechanism will only allow the adjustment knobs to be rotated when the dumbbell handle is completely inserted and engaging the dumbbell base.
2. The mechanism is designed to lock the dumbbell handle to the base if either adjustment knob is not fully engaging the selected weight plates.

Purpose

The locking mechanism serves two important purposes:

1. The mechanism will prevent deselecting (dropping) weight plates from the dumbbell when it is NOT in the dumbbell base.
2. The mechanism will prevent partial selection of the weight plates in which the plates are not fully supported and the locking pin is not fully engaged.

Given the importance of this locking mechanism, it is critical that you understand how it operates and how to periodically test it to make sure it is functioning correctly.

Testing proper locking mechanism function

1. With the dumbbell handle set in the dumbbell base, turn both adjustment knobs to the number 10. You will know you have fully and correctly selected the number when you feel the adjustment knob settle into a notch (known as a detent). You will also hear a slight, but audible, clicking noise that corresponds with the detent locations for each number.



2. You should be able to withdraw the handle from the base leaving all the weight plates behind.

3. With the handle removed from the base, grab one adjustment knob with your other hand and gently attempt to turn the knob. The knob should not rotate. A locking pin in the mechanism will have engaged the rotational assembly when the unit was withdrawn from the base. Perform this test with all adjustment knobs.



Do not use too much force to try to turn the locked adjustment knob. Too much force can damage the locking mechanism.

4. After confirming the proper function of the locking mechanism as described above, return and fully insert the dumbbell handle back into the base assembly.
5. With the handle back in the base, turn the adjustment knob on one side to a position that is in-between the 10 and 15 number. This represents an incomplete weight selection where the adjustment knob has not fully selected a weight and the knob is in-between the selection detents (clicks).

6. With the selection knob in this improper position, gently attempt to lift up on the handle to remove it from the base. You should find that the handle is locked to the base and cannot be removed with light pressure as it can normally.



7. Return the improperly selected adjustment knob to a full and proper weight selection and assure that the dumbbell handle can once again be removed.
8. Repeat this test for all adjustment knobs.
9. Assure the entire dumbbell handle assembly is properly tightened. Do this by setting the adjustment knobs to 10 pounds and removing the handle assembly from the base. Grab both adjustment knobs and very slightly push and pull the knobs toward and away from the handle grip. The knobs should not exhibit free play and all of the selection discs should feel tightly connected.
10. You have now tested the function of the locking mechanism. We suggest you repeat this test periodically (once a month) to confirm the proper function of the locking mechanism.



Do not engage the locking mechanism and use the handle to try to lift the dumbbell and base together. To lift the dumbbell and base together, engage the locking mechanism and use the lift handles molded into the base assembly.

If the dumbbell locking mechanism operates unsatisfactorily in the test procedure above, do the following:

1. Stop use of the product immediately until approved service is available.
2. Contact Nautilus, Inc. directly by phone at 1-800-NAUTILUS (628-8458) for service.

Offset weight selection

As indicated above, proper selection for a given weight is accomplished by selecting that weight number on both ends of the dumbbell. For example: to select 20 lbs, one must dial both adjustment knobs on the dumbbell to the number 20. By selecting the same number on both sides of the dumbbell, you will replicate a common dumbbell, this is to say, a balanced dumbbell with equal weight on both sides. While this is the most common form of weight selection and will be used in the vast majority of workouts, the Bowflex® SelectTech® Dumbbell offers a useful and unique workout alternative known as offset weight selection. Offset weight selection involves using a different weight setting on one side of the dumbbell relative to the other. Doing so can be a powerful muscle development tool during certain workouts, such as the biceps curl. The SelectTech® Dumbbell functions exactly the same way whether you have selected balanced or offset weights. The only exception is that when you are using offset weights, you must return the dumbbell to the base in the same orientation that you removed it. When you have offset weight selection the combination of weight plates selected will not be the same on both sides of the dumbbell. You must therefore make certain to return the dumbbell to the base in the same orientation

in which it was removed, in order for the weight plates to settle back into the corresponding vacant slots in the dumbbell base.

Example of offset weight selection workout

Performed traditionally, dumbbell curls strengthen the biceps, but do little for the forearm muscles that assist in supination and pronation of the wrist. Supination and pronation are terms describing a rotating motion of the wrist. For example, turning a doorknob and turning your key in your car's ignition are examples of supination and pronation. Turning a doorknob clockwise would be the supination direction, while counter-clockwise would be the pronation direction. Whether you are training for a specific sport, or just training to become stronger and improve activities of daily living, training your forearm muscles that are involved in supination and pronation can be beneficial.

These dumbbells allow you to train differently than traditional dumbbells. By using different weight settings on either side of the dumbbells, you can use those supination/pronation muscles during your curls. Using more weight on the thumb side of the dumbbell will improve pronation strength, while more weight on the little finger side will improve supination strength. Not only will you be strengthening your biceps, but also you can become stronger in activities involving rotation of the wrist!

The following example of a Biceps Curl using offset weight is a good demonstration of the superior muscle development provided by the SelectTech® Dumbbell.

The dumbbell weight has been set to 20 lbs on one side and 30 lbs on the other. The total weight of the dumbbell is therefore 25 lbs. This 25-lb dumbbell has the weight distributed such that there are 10 lbs on one side and 15 lbs. on the other for a total of 25 lbs.

	Side 1	Side 2	Total dumbbell weight
Weight settings selected	20lbs	30 lbs	25 lbs
Weight Difference		10 lbs	
Weight Distribution	10 lbs	15 lbs	25 lbs
Weight offset		+ 5 lbs	

With the dumbbell weight configured as defined above, the user should grip the dumbbell with 20 lbs on the thumb side of the hand and the 30 lbs on the little finger side of the hand.

Start the biceps curl with a neutral wrist and forearm position (palm facing leg). As the curl progresses from the start to finish position, the wrist should be rotated progressively outward (palm up). During this curl the user will be lifting the weight of the dumbbell (25 lbs) with the biceps but also lifting the offset weight of 5 lbs with wrist rotation (supination). Unlike a conventional dumbbell that is balanced end to end, this offset weight will require more muscle activation and therefore develop the forearm and wrist.

Below you will find some helpful charts that will provide the total dumbbell weight for various combinations of weight settings.



This is just one example of the offset weight settings you may use. The weight combinations and totals are quite extensive given the adjustment options of the SelectTech® Dumbbell.

10																				
15	12.5																			
20	15	17.5																		
25	17.5	20	22.5																	
30	20	22.5	25	27.5																
35	22.5	25	27.5	30	32.5															
40	25	27.5	30	32.5	35	37.5														
45	27.5	30	32.5	35	37.5	40	42.5													
50	30	32.5	35	37.5	40	42.5	45	47.5												
55	32.5	35	37.5	40	42.5	45	47.5	50	52.5											
60	35	37.5	40	42.5	45	47.5	50	52.5	55	57.5										
65	37.5	40	42.5	45	47.5	50	52.5	55	57.5	60	62.5									
70	40	42.5	45	47.5	50	52.5	55	57.5	60	62.5	65	67.5								
75	42.5	45	47.5	50	52.5	55	57.5	60	62.5	65	67.5	70	72.5							
80	45	47.5	50	52.5	55	57.5	60	62.5	65	67.5	70	72.5	75	77.5						
85	47.5	50	52.5	55	57.5	60	62.5	65	67.5	70	72.5	75	77.5	80	82.5					
90	50	52.5	55	57.5	60	62.5	65	67.5	70	72.5	75	77.5	80	82.5	85	87.5				
	10	15	20	25	30	35	40	45	50	55	60	65	70	75	80	85	90			

Indicates weight setting on adjustment knob

Use the matrix above to quickly determine the offset weight selection total for your dumbbell.

The chart to the right is a quick reference to determine the amount of weight offset to one side of the dumbbell.

The symbol + indicates the amount of offset weight on the heavier side of the dumbbell.

Although you can continue to increase the amount of weight offset, it is not generally necessary to offset the weight more than 20 lbs.

Difference	Offset
5 lbs	+ 2.5 lbs
10 lbs	+ 5 lbs
15 lbs	+ 7.5 lbs
20 lbs	+ 10 lbs
25 lbs	+ 12.5 lbs
30 lbs	+ 15 lbs
35 lbs	+ 17.5 lbs
40 lbs	+ 20 lbs

Bowflex® SelectTech® Dumbbell Maintenance

The Bowflex® SelectTech® Dumbbell is a very low maintenance product. However, there are steps that you should take to keep the product performing and looking its very best.

1. Should your SelectTech® Dumbbell handle assembly, plates or base become soiled you may clean them with a rag lightly dampened with warm water and a small amount of mild soap. Wipe dry with a separate rag.
2. The SelectTech® Dumbbell is internally lubricated and will not require further internal lubrication. The contact between weight plates and selection discs is not lubricated but has naturally low friction. This generally will not require any lubrication. Should you feel it necessary to lubricate the weight plates and/or selection discs, use only a silicon lubricant, preferably "food grade".



Do not use any solvents, harsh detergents, chemicals or bleach on this product – doing so may damage the materials, resulting in degradation of the product's performance or strength.

Do not attempt to disassemble the dumbbell handle or base assembly. These items are not designed to be user serviced. Doing so will void the manufacturer's warranty. Contact your Bowflex® retailer or Nautilus, Inc. directly for service.

Bowflex® SelectTech® 2-in-1 Dumbbell Stand (optional) - Model BDS1642

This attractive stand features an ergonomic design to enhance the functionality of the SelectTech® Dumbbell.

- The V-shape “step-in” design allows the user to maintain proper upper body position while lifting or returning the dumbbells to the base.
- The dumbbell handles are positioned in a natural orientation providing a comfortable and secure lifting position.
- Large adjustable stabilizer feet assure maximum stability.
- Includes two “seat belts” to secure dumbbells to the base.
- Integrated towel rack.
- Dimensions (without dumbbells): 20" L x 26.1" W x 23.5" H (51cm x 66.3cm x 59.8cm)

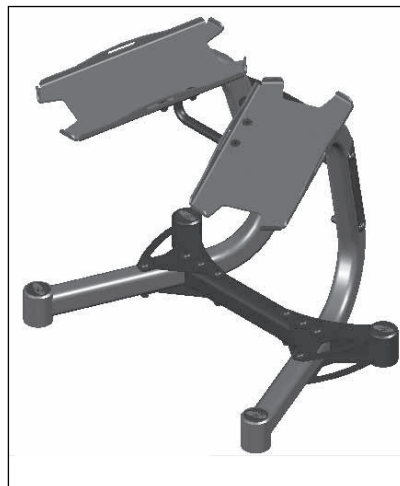

Optional exercise bench and mat are available separately.

Check out the selection of products available at www.bowflexselecttech.com

Troubleshooting guide

Problem	Solution
Dumbbell handle does not fully insert into base when no plates are selected (handle has no plates attached).	<ol style="list-style-type: none"><li data-bbox="687 327 1374 387">1. Make certain that both adjustment knobs are set directly to the number 10.
Dumbbell handle does not fully insert into base when plates are selected (handle has plates attached).	<ol style="list-style-type: none"><li data-bbox="687 622 1465 813">1. Check to see if you have selected different weights on each side of the dumbbell (for example one adjustment knob is set to 10 and the other is set to 15). If this is the case, you must replace the dumbbell in the base with the same orientation in which was withdrawn. This is to allow the plates to settle back into the correct and vacant openings in the base.<li data-bbox="687 813 1465 943">2. Verify that the plates not selected (those plates remaining in the dumbbell base) are in their correct spots and have not been moved to a different support slot. This may be blocking the dumbbell from fitting back into the base.
Adjustment knob will not turn while handle is in base.	<ol style="list-style-type: none"><li data-bbox="687 1099 1465 1193">1. Check to assure that the dumbbell handle is fully depressed into the dumbbell base. If not fully depressed, the locking mechanism will not be released and may be keeping the adjustment knobs from rotating.<li data-bbox="687 1193 1465 1323">2. Check to see if any weight plates have been forced into the base assembly backwards with the "support tongue" facing the grip of the dumbbell handle. All weight plates must have the locking tab facing away from the grip of the dumbbell handle.<li data-bbox="687 1323 1465 1453">3. Check to see if there is any dirt, debris or other obstruction in the dumbbell base. You may need to remove the weight plates from the base to accomplish this check. Remember to put each weight plate back in its appropriate location.

SelectTech® 6 Week Challenge

FREQUENCY: 3 Days a Week

TIME: About 30 minutes

For a successful workout, focus on generating the muscular contraction required to create the motion of the weight (demonstrated in your "The Secrets of the 4-Step Rep" DVD) not just lifting the weight.

of Reps: 8-12 (30 to 40 second intervals between sets)

Workout 1	Set #1		Set #2		Set #3	
	Weight	Reps	Weight	Reps	Weight	Reps
Flat Chest Press						
Overhead Press						
Lying Triceps Extension						
Overhead Triceps Extension						
Single Arm Row						
Standing Curl						
Concentration Curls						
Workout 2	Set #1		Set #2		Set #3	
	Weight	Reps	Weight	Reps	Weight	Reps
Stationary Lunge						
Stiff-Leg Dead Lift						
Calf Raise						
Ab Crunch						
Lying Trunk Rotation						
Workout 3	Set #1		Set #2		Set #3	
	Weight	Reps	Weight	Reps	Weight	Reps
Flat Chest Press Alternating						
Overhead Press Alternating						
Lying Triceps Extension						
Overhead Triceps Extension						
Single Arm Row						
Standing Curl Alternating						
Concentration Curls						
Workout 4	Set #1		Set #2		Set #3	
	Weight	Reps	Weight	Reps	Weight	Reps
Stationary Lunge						
Stiff-Leg Dead Lift						
Calf Raise Unilateral						
Reverse Crunch						
Lying Trunk Rotation						

Workout 5	Set #1		Set #2		Set #3	
	Weight	Reps	Weight	Reps	Weight	Reps
30d Incline Chest Press						
Lateral Raise						
Overhead Triceps Extension						
Triceps Kickback						
Wide Row						
60d Incline Curl						
Scott Curl						
Workout 6	Set #1		Set #2		Set #3	
	Weight	Reps	Weight	Reps	Weight	Reps
Wide Squat						
Calf Raise						
Ab Crunch						
Lying Trunk Rotation						
Workout 7	Set #1		Set #2		Set #3	
	Weight	Reps	Weight	Reps	Weight	Reps
30d Incline Chest Press						
Lateral Raise						
Overhead Triceps Extension						
Triceps Kickback						
Wide Row						
60d Incline Curl						
Scott Curl						
Workout 8	Set #1		Set #2		Set #3	
	Weight	Reps	Weight	Reps	Weight	Reps
Wide Squat						
Calf Raise						
Reverse Crunch						
Lying Trunk Rotation						
Workout 9	Set #1		Set #2		Set #3	
	Weight	Reps	Weight	Reps	Weight	Reps
Flat Chest Press						
60d Incline Press						
Overhead Triceps Extension						
60d Incline Triceps Extension						
Single Arm Row						
Standing Curl						
60d Incline Curl						

Workout 10	Set #1		Set #2		Set #3	
	Weight	Reps	Weight	Reps	Weight	Reps
Stiff-Leg Dead Lift						
Wide Squat						
Calf Raise						
Reverse Crunch						
Lying Trunk Rotation						
Workout 11	Set #1		Set #2		Set #3	
	Weight	Reps	Weight	Reps	Weight	Reps
Flat Chest Press						
60d Incline Press						
Lying Triceps Extension						
60d Incline Triceps Extension						
Single Arm Row						
Standing Curl						
60d Incline Curl						
Workout 12	Set #1		Set #2		Set #3	
	Weight	Reps	Weight	Reps	Weight	Reps
Stiff-Leg Dead Lift						
Wide Squat						
Calf Raise						
Reverse Crunch						
Lying Trunk Rotation						
Workout 13	Set #1		Set #2		Set #3	
	Weight	Reps	Weight	Reps	Weight	Reps
Flat Fly						
Flat Chest Press						
Seated Overhead Press Bilateral						
Lying Triceps Extension						
Overhead Triceps Extension						
Single Arm Row						
Wide Row						
Standing Curl						
Scott Curl						
Workout 14	Set #1		Set #2		Set #3	
	Weight	Reps	Weight	Reps	Weight	Reps
Wide Squat						
Reverse Lunge						
Calf Raise						
Reverse Crunch						
Lying Trunk Rotation						

Workout 15	Set #1		Set #2		Set #3	
	Weight	Reps	Weight	Reps	Weight	Reps
Flat Fly						
Flat Chest Press						
Seated Overhead Press						
Lying Triceps Extension						
Overhead Triceps Extension						
Single Arm Row						
Rear Delt Row						
Standing Curl						
Scott Curl						
Workout 16	Set #1		Set #2		Set #3	
	Weight	Reps	Weight	Reps	Weight	Reps
Wide Squat						
Reverse Lunge						
Calf Raise						
Reverse Crunch						
Lying Trunk Rotation						
Workout 17	Set #1		Set #2		Set #3	
	Weight	Reps	Weight	Reps	Weight	Reps
Flat Fly						
Flat Chest Press						
Lateral Raise						
Lying Triceps Extension						
Overhead Triceps Extension						
Single Arm Row						
Rear Delt Row						
Standing Curl						
Scott Curl						
Workout 18	Set #1		Set #2		Set #3	
	Weight	Reps	Weight	Reps	Weight	Reps
Stiff-Leg Dead Lift						
Wide Squat						
Calf Raise						
Ab Crunch						
Lying Trunk Rotation						

SELECT TECH MENU PLAN

For Females

You may choose plan A, B, C or D for each meal or snack

BREAKFAST: 300-335 calories

- A. 1/2 New York style bagel (125)
2 TBSP of cream cheese or 1 TSP of peanut butter (100)
1 cup of orange juice (110)
- B. 1/2 serving of Champion Metabolol II® (130)
1 cup of 1% milk (200)
- C. 1 cup of Honey Nut Cheerios® (115)
1/2 cup of 1% milk (100)
1 cup of orange juice (110)
- D. 1 egg, any style (80)
1 slice of whole-grain bread (75)
1 cup of orange juice (110)
1 TSP of butter or margarine (35)

MORNING SNACK: 180-215 calories

- A. 1/2 serving of Champion Met Max (115)
1/2 cup of 1% milk (100)
- B. 1 Champion SnacBar (180)
- C. 1 cup of 1% low-fat cottage cheese (180)
- D. 6 oz. of Yoplait® 99% fat free yogurt (180)

LUNCH: 350-380 calories

- A. 2 slices of whole-grain bread (150)
1.5 oz. of turkey, ham, chicken or tuna fish (75)
1 TBSP of light mayonnaise (50)
(lettuce, tomato, onion and pickles optional)
1 serving of medium-sized fruit (100)
- B. 3 oz. of boneless, skinless chicken breast (150)
3/4 cup of cooked rice (preferably brown) (150)
1 cup of broccoli (80)
- C. 1 serving of Champion Metabolol II® (260)
1/2 cup of 1% milk (100)
- D. Frozen Microwave meal of no more than 350 calories. You may choose from Healthy Choice®, Lean Cuisine® or Michelina's® Authentico, for example.

AFTERNOON SNACK: 180-215 calories

- A. 1/2 serving of Champion Met Max (115)
1/2 cup of 1% milk (100)
- B. 2 servings of medium-sized fruit (200)
- C. 1 cup of 1% low-fat cottage cheese (180)
- D. 6 oz. of Yoplait® 99% fat free yogurt (180)

DINNER: 350-360 calories

- A. 3 oz. of Chicken, Turkey or Fish (150)
1/2 medium baked potato or 1/2 cup of cooked rice (preferably brown) (100)
Side salad with 2 TBSP of low-fat dressing or 2 cups of broccoli (100)
- B. Frozen Microwave dinners of no more than 350 calories. You may choose from Healthy Choice®, Lean Cuisine® or Michelina's® Authentico, for example.
- C. 1 serving of Champion Metabolol II® (260)
1/2 cup of 1% milk (100)
- D. 1 oz. spaghetti, American Beauty® thin, uncooked (105)
3 oz. ground turkey, Louis Rich® (140)
1/2 cup of tomato sauce (30)
1 cup of desired vegetables sautéed with ground turkey (80)

EVENING SNACK (optional): 100-180 calories

- A. 1 Champion SnacBar (180)
- B. 1 serving of medium-sized fruit (100)

CHAMPION CREATINE SUPPLEMENT: On weight-training days, please take one serving before your workout and one serving after your workout. CREATINE CALORIES...280 on workout days.

BEVERAGES: Please follow the hydration program for your water intake. You may also have soft drinks, tea or coffee as long as it's calorie and caffeine free. This would be in addition to your water.

TOTAL CALORIES WILL DEPEND ON WHETHER YOU CHOOSE OPTION A, B, C OR D DURING THE DAY

Workout days: LOW 1640 HIGH 1785
Off days: LOW 1360 HIGH 1505

SELECT TECH MENU PLAN

For Males

You may choose plan A, B, C or D for each meal or snack

BREAKFAST: 455-490 calories

- A. 1 New York style bagel (250)
2 TBSP of cream cheese or 1 TSP of peanut butter (100)
1 cup of orange juice (110)
- B. 1 serving of Champion Metabolol II® (260)
1 cup of 1% milk (200)
- C. 2 cups of Honey Nut Cheerios (230)
3/4 cup of 1% milk (150)
1 cup of orange juice (110)
- D. 2 eggs, any style (160)
2 slices of whole-grain bread (150)
1 cup of orange juice (110)
1 TSP of butter or margarine (35)

MORNING SNACK: 280-315 calories

- A. 1/2 serving of Champion Met Max (115)
1 cup of 1% milk (200)
- B. 1 Champion SnacBar (180)
1 serving of medium-sized fruit (100)
- C. 1 cup of 1% low-fat cottage cheese (180)
1 serving of medium-sized fruit (100)
- D. 6 oz. of Yoplait® 99% fat free yogurt (180)
1 serving of medium-sized fruit (100)

LUNCH: 425-460 calories

- A. 2 slices of whole-grain bread (150)
3 oz. of turkey, ham, chicken or tuna fish (150)
1 TBSP of light mayonnaise (50)
(lettuce, tomato, onion and pickles optional)
1 serving of medium-sized fruit (100)
- B. 3 oz. of boneless, skinless chicken breast (150)
1 cup of cooked rice (preferably brown) (200)
1 cup of broccoli (80)
- C. 1 serving of Champion Metabolol II® (260)
1 cup of 1% milk (200)
- D. Frozen Microwave meal of no more than 350 calories. You may choose from Healthy Choice®, Lean Cuisine® or Michelina's® Authentico, for example.
1 slice of whole-grain bread (75)

AFTERNOON SNACK: 280-315 calories

- A. 1/2 serving of Champion Met Max (115)
1 cup of 1% milk (200)
- B. 1 Champion SnacBar (180)
1 serving of medium-sized fruit (100)
- C. 1 cup of 1% low-fat cottage cheese (180)
1 serving of medium-sized fruit (100)
- D. 6 oz. of Yoplait® 99% fat free yogurt (180)
1 serving of medium-sized fruit (100)

DINNER: 425-460 calories

- A. 3 oz. of chicken, turkey or fish (150)
1 medium-sized baked potato or 1 cup of cooked rice (preferably brown) (200)
Side salad with 2 TBSP of low-fat dressing or 2 cups of broccoli (100)
- B. Frozen Microwave dinners of no more than 350 calories. You may choose from Healthy Choice®, Lean Cuisine® or Michelina's® Authentico, for example.
1 slice of whole-grain bread (75)
- C. 1 serving of Champion Metabolol II® (260)
1 cup of 1% milk (200)
- D. 2 oz. spaghetti, American Beauty® thin, uncooked (210)
3 oz. ground turkey, Louis Rich® (140)
1/2 cup of tomato sauce (30)
1 cup of desired vegetables sautéed with ground turkey (80)

EVENING SNACK (optional): 180-315 calories

- A. 1/2 serving of Champion Met Max (115)
1 cup of 1% milk (200)
- B. 1 Champion SnacBar (180)

CREATINE SUPPLEMENT: On weight-training days, please take one serving before your workout and one serving after your workout. CREATINE CALORIES...280 on workout days.

BEVERAGES: Please follow the hydration program for your water intake. You may also have soft drinks, tea or coffee as long as it's calorie and caffeine free. This would be in addition to your water.

TOTAL CALORIES WILL DEPEND ON WHETHER YOU CHOOSE OPTION A, B, C OR D DURING THE DAY

Workout days: LOW 2145 HIGH 2320
Off days: LOW 1865 HIGH 2040

This page intentionally left blank.

Wide Squats

Muscles worked

Quadriceps, glutes, hamstrings and adductors



Success tips:

- Keep the knees pointed in the same direction as the toes.
- Keep the head and neck in line with the trunk.
- Pay close attention to all alignment and stabilization issues on every part of each repetition.

START

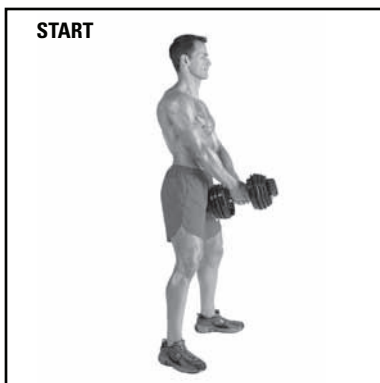

START

- Grab the dumbbell with both hands and stand with your feet slightly wider than shoulder width apart.
- Slightly rotate your hips and legs outward, so that your feet and knees are lined up pointing outward.
- Stabilize your torso by lifting your chest, tightening your abs, and maintaining a slight arch in your lower back.

FINISH

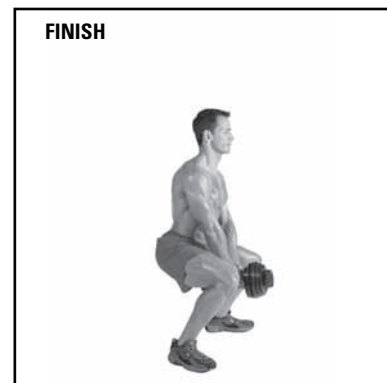

ACTION

- Under control, slowly squat down by sticking the hips back as the knees start to bend.
- Keep the chest up and the and back flat as the hips continue to move backward.
- Lower to approximately 90 degrees at the knees, unless otherwise determined.
- Return to the starting position.
- Do not lockout the knees at the top of the squat.

Calf Raises

Muscles worked

Gastrocnemius and soleus



Success tips

- Do not change your hip or knee position during the exercise.
- Rise up as high as you can, maintaining your balance, on the balls of your feet.

START

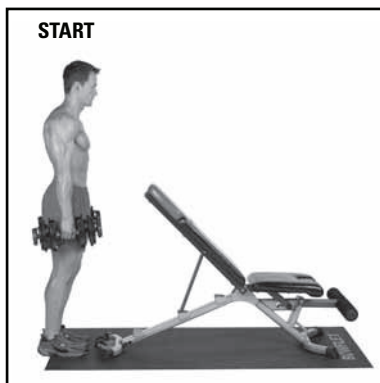

START

- Stand with your feet about shoulder width apart, feet facing straight forward.
- Hold the dumbbells at your sides with your palms facing in.
- Keep your chest lifted, abs tight and a slight curve in your lower back.

FINISH



ACTION

- Slowly rise up on the balls of your feet, lifting your heels as high as you can off the floor.
- Slowly return to the starting position, keeping tension on the calf muscles.

Stationary Lunges

Muscles worked

Quadriceps, glutes, hamstrings and adductors



Success tips

- Place feet in a position so that when you lunge down, your front foot is directly under your knee and your back leg lines up under your hip.
- Keep your head and chest lifted, with a slight arch in the lower back during the movement.
- Do only one side to fatigue, then switch to the other side.

START



START

- Stand with one foot forward and one foot backward in a position so when you move to the bottom of the lunge, your front foot is under your knee and your back knee is directly under you hip.
- Hold the dumbbells at your sides with your palms facing inward.
- Keep the chest lifted, abs tight and a slight arch in the lower back.

FINISH



ACTION

- Slowly lower your body bending at both knees, simultaneously keeping the front knee in line with the toes.
- Move down and stop just before the back knee is going to touch the floor.
- Reverse the motion and come back up to the starting position.

Stiff-leg Dead Lift

Muscles worked

Hamstrings, glutes and spinal erectors



Success tips

- Your torso should move from standing vertical to leaning forward at the hips without rounding your spine during any part of the movement.
- Keep the knees slightly bent.
- Only move as far as you can correctly.
- It is critical that you keep the chest lifted and do not allow your spine to round at any time during the movement.

START

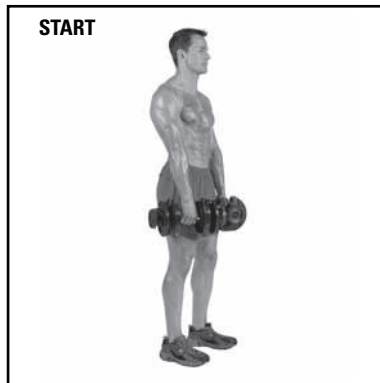

START

- Stand with your feet approximately shoulder width apart
- Hold the dumbbells down in front of your thighs with your palms facing back.
- Stand with a very slight bend at the knees.
- Keep the chest lifted, abs tight and a very slight arch in your lower back.

FINISH

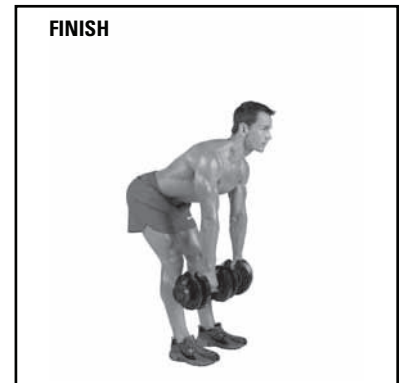

ACTION

- Maintaining your knee position, slowly bend forward at the hips moving your butt backward.
- Stop as your hamstrings begin to get taut and before your back begins to round.
- Concentrate on tensing your hamstrings to pull you back up to the starting position.

Reverse Lunge

Muscles worked

Quadriceps, glutes, hamstrings and adductors

Success tips

- Place feet in a position so that when you lunge back, your front foot is directly under your knee and your back leg lines up under your hip.
- Keep your head and chest lifted, with a slight arch in the lower back during the movement.
- Do only one side to fatigue and then switch to the other side.

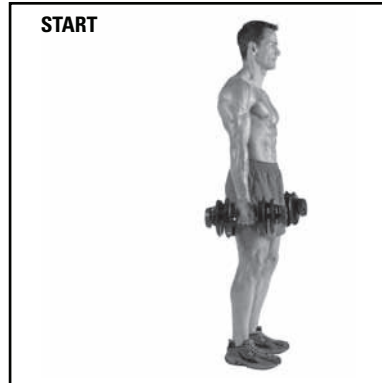

START

START

- Stand with your feet together.
- Hold the dumbbells at your sides with your palms facing inward.
- Keep the chest lifted, abs tight, and a slight arch in the lower back.



FINISH

ACTION

- Initiate the movement by tightening your glutes and slowly pivoting your leg from your hip. Move your entire leg backward, keeping your knee steady at a 90 degree angle.
- Slowly move your leg as far as you can, without allowing any movement at the waist, knee or lower back.
- Slowly return to start position.

Flat Chest Press

Muscles worked

Pectoralis major, deltoids and triceps

Bench position

Flat

Success tips

- Maintain a 60-90 degree angle between your upper arms and torso at the start of the motion, and a 90 degree angle from your torso at the top.
- Keep knees bent so your feet are positioned flat on the floor directly under your knees.
- Do not let your elbows travel behind your shoulders when you are lowering the dumbbells.
- Keep shoulder blades pinched together and maintain good spinal alignment.

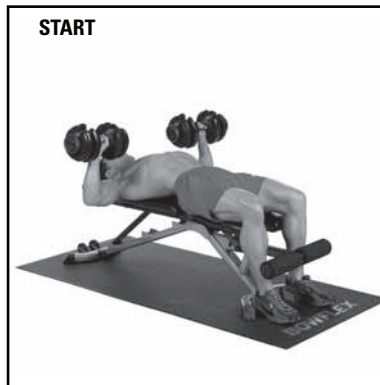
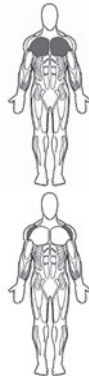

START

- Grab the dumbbells and lie back on the bench.
- Bend your elbows back keeping your arms at approximately 60-90 degrees away from your sides, and your elbows equal to your shoulder.
- Keep your arms directly in line with the dumbbell, over your wrists and elbows.
- Raise your chest, pinch your shoulder blades together and maintain a comfortable arch in your lower back.

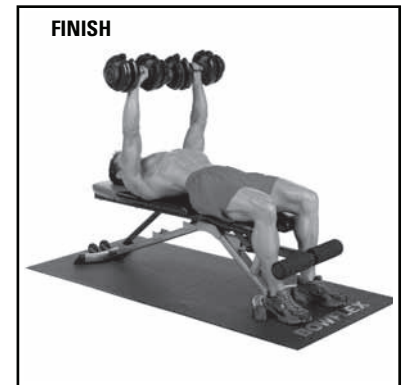

ACTION

- Slowly press the dumbbells upward, straightening your arms while moving the dumbbells toward each other, directly over the center of your chest.
- Don't lock out your elbows, keep the tension on the chest.
- Slowly return to the starting position, keeping your wrists steady and your movements slow and controlled.

Incline Chest Press

Muscles worked

Pectoralis major, deltoids and triceps

Bench position

Inclined to 45 degrees

Success tips

- Maintain a 60-90 degree angle between your upper arms and torso at the start of the motion and slightly more than 90 degrees from your torso at the top.
- Keep knees bent so your feet are positioned flat on the floor directly under your knees.
- Do not let your elbows travel behind your shoulders when you are lowering the dumbbells.
- Keep shoulder blades pinched together and maintain good spinal alignment.
- Keep your arms directly in line with the dumbbell over your wrists and elbows.

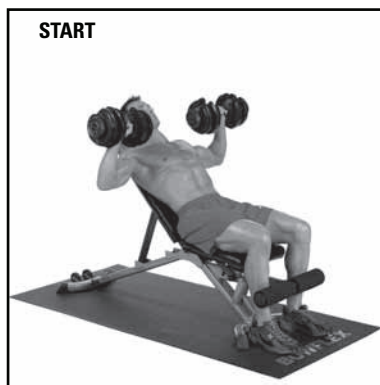

START

- Grab the dumbbells and lie back on the bench.
- Bend your elbows back, keeping your arms at approximately 60-90 degrees away from your sides, and your elbows equal to your shoulder.
- Raise your chest, pinch your shoulder blades together and maintain a comfortable arch in your lower back.



ACTION

- Slowly press the dumbbells upward, straightening your arms while moving the dumbbells toward each other, directly over the center of your chest.
- Don't lock out your elbows, keep the tension on the chest.
- Slowly return to the starting position, keeping your wrists steady and your movements slow and controlled.

Flat Chest Fly

Muscles worked

Pectoralis major and deltoids

Bench position

Flat

Success tips

- Maintain a 60-90 degree angle between your upper arms and torso at the start of the motion, and slightly more than 90 degrees from your torso at the top.
- Keep knees bent so your feet are positioned flat on the floor directly under your knees.
- Do not let your elbows travel behind your shoulders when you are lowering the dumbbells.
- Keep shoulder blades pinched together and maintain good spinal alignment.

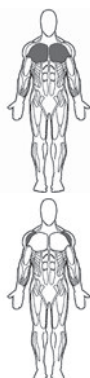

START

- Grab the dumbbells and lie back on the bench.
- Rotate your upper arms away from your torso so that your elbows and palms are pointing upward.
- Maintain a slight bend at the elbow and stabilize your wrist in a neutral position.
- Raise your chest, pinch your shoulder blades together and maintain a comfortable arch in your lower back.



ACTION

- Slowly move the dumbbells forward, then upward, keeping your arms stable at the elbow, while moving the dumbbells toward each other directly over the center of your chest.
- Keep the tension on the chest throughout the movement.
- Slowly return to the starting position, keeping your wrists steady and your movement slow and controlled.

Incline Chest Fly

Muscles worked

Pectoralis major and deltoid

Bench position

Inclined 45 degrees

Success tips

- Maintain a 60-90 degree angle between your upper arms and torso at the start of the motion, and slightly more than 90 degrees from your torso at the top.
- Keep knees bent so your feet are positioned flat on the floor directly under your knees.
- Do not let your elbows travel behind your shoulders when you are lowering the dumbbells.
- Keep shoulder blades pinched together and maintain good spinal alignment.



START

- Grab the dumbbells and lie back on the bench.
- Rotate your upper arms away from your torso so that your elbows and palms are pointing upward.
- Maintain a slight bend at the elbow and stabilize your wrist in a neutral position.
- Raise your chest, pinch your shoulder blades together, and maintain a comfortable arch in your lower back.



ACTION

- Slowly move the dumbbells forward, then upward, keeping your arms stable at the elbow. Move the dumbbells toward each other directly over the center of your upper chest.
- Keep the tension on the chest throughout the movement.
- Slowly return to the starting position.

Decline Chest Press

Muscles worked

Pectoralis major, deltoids and triceps

Bench position

Declined

Success tips

- Maintain a 60-90 degree angle between your upper arms and torso at the start of the motion, and 90 degree angle from your torso at the top.
- Keep knees bent so your feet are positioned flat on the floor directly under your knees.
- Do not let your elbows travel behind your shoulders when you are lowering the dumbbells.
- Keep shoulder blades pinched together and maintain good spinal alignment.
- Keep your arms directly in line with the dumbbell over your wrists and elbows.

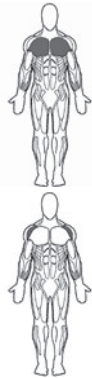

START



FINISH

START

- Grab the dumbbells and lie back on the bench.
- Bend your elbows back, keeping your arms at approximately 60-90 degrees away from your sides, and your elbows equal to your shoulder.
- Raise your chest, pinch your shoulder blades together and maintain a comfortable arch in your lower back.

ACTION

- Slowly press the dumbbells upward, straightening your arms while moving the dumbbells toward each other, directly over the center of your chest.
- Don't lock out your elbows. Keep the tension on the chest.
- Slowly return to the starting position, keeping your wrists steady and your movements slow and controlled.

Standing Curls

Muscles worked

Biceps and other elbow flexors



Success tips

- Keep elbows at your sides.
- Keep your wrists straight.
- Keep your trunk muscles tight and maintain a very slight arch in your lower back.

START



START

- Hold the dumbbells with your hands facing forward.
- Stand with your upper arms by your sides, lift your chest, tighten your abdominals, and maintain a very slight arch in your lower back.

FINISH



ACTION

- Curl the dumbbells forward, then upward, and then toward your shoulders while keeping your elbows at your sides and your upper arms completely still.
- Slowly lower to the starting position by performing the same arcing motion.

Concentration Curls

Muscles worked

Biceps and other elbow flexors



Bench position

Flat

Success tips

- Do not rock the upper body while bending the elbow.
- Keep your wrist straight.
- Keep your chest lifted, trunk muscles tight, and maintain a very slight arch in your lower back.

START



START

- Sit on the bench sideways and place your feet flat on the floor slightly wider than shoulder width.
- Grab the dumbbell and rest the back of your upper arm against the inside of your leg just above the knee.
- The arm holding the dumbbell should be slightly bent, maintaining tension on the biceps.
- Maintain a good spinal alignment.

FINISH



ACTION

- Curl the forearm toward the upper arm, keeping your upper arm and shoulder blade completely still.
- Slowly return to the starting position without relaxing the biceps.

Incline Bench Curls

Muscles worked

Biceps and other elbow flexors

Bench position

Inclined to 45 degrees



Success tips

- Keep tension on the biceps throughout the movement. Don't allow the arm to go to full extension.
- Keep your wrist straight.
- Keep your chest lifted, trunk muscles tight and maintain a very slight arch in your lower back.

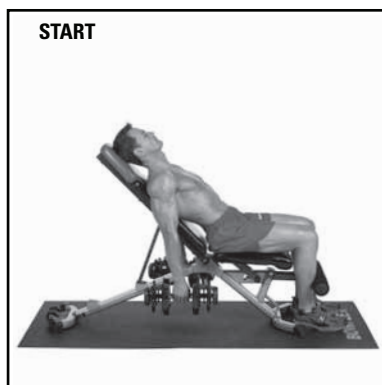

START

- Grab the dumbbells and sit on the inclined bench and place your feet flat on the floor directly under your knees.
- Hold the dumbbell with a slight bend at the elbow maintaining tension on the biceps.
- Maintain a good spinal alignment with the chest lifted and the abs tight.



FINISH

ACTION

- Curl the forearms toward the upper arm, keeping your upper arm and shoulder blade completely still.
- Slowly return to the starting position without relaxing the biceps.

Scott Curls — Standing Concentration Curls

Muscles worked

Biceps and other elbow flexors

Bench position

Inclined to 60 degrees



Success tips

- Do not rock the upper body while bending the elbow.
- Keep your wrist straight.
- Keep your chest lifted, trunk muscles tight, and maintain a very slight arch in your lower back.
- Stop the arm motion at the top of the movement slightly before your arm is straight up.
- Keep feet slightly wider than shoulder width.



START

- Grab the dumbbell and rest the back of your upper arm against the upper portion of the bench pad.
- The arm holding the dumbbell should be slightly bent, maintaining tension on the biceps.
- Place the other arm between the bench and the upper arm.
- Maintain a good spinal alignment.



FINISH

ACTION

- Curl the forearm toward the upper arm, keeping your upper arm and shoulder blade completely still.
- Slowly return to the starting position without relaxing the biceps.

Overhead Triceps Extension

Muscles Worked

Triceps



Success tips

- Keep your knees slightly bent with your feet approximately shoulder width apart.
- Keep your chest lifted, shoulders pinched together, and a very slight arch in your lower back.
- Keep your upper arms and shoulders motionless and your wrists straight.
- Tighten your triceps throughout the exercise, using a controlled motion.

START



START

- Stand with your knees slightly bent and feet shoulder width apart.
- Place both hands over the inside edge of one side of the dumbbell weights.
- Bring the arms up over your head with an approximate 90 bend at the elbow.

FINISH



ACTION

- Keeping your upper arms stable, slowly straighten your elbows, moving your arms in a arcing motion upward over your head.
- Stop the motion before your arms are completely straight, and then reverse the motion, slowing returning to the starting position, keeping tension on the muscle.

Triceps Kickback

Muscles Worked

Triceps



Bench position

Flat

Success tips

- Maintain spinal alignment.
- Keep your arm at your side and your wrist straight throughout the entire motion.
- Tighten your triceps throughout the exercise and control the motion.

START



START

- Kneel with one leg on the bench, bend forward at the hips, and place one hand on the bench.
- Support yourself with one arm on the bench and hold the dumbbell with the other with your palm facing in.
- Keeping your elbow bent, bring your upper arm to your side, parallel to the ground.

FINISH



ACTION

- Straighten the elbow while keeping your upper arm completely still.
- When the arm is completely straight, slowly return to the starting position.

Lying Triceps Extension

Muscles worked

Triceps

Bench position

Flat



Success tips

- Keep the upper arm motionless.
- Keep the wrists straight.
- Tighten your triceps throughout the exercise and control the motion all the way down.
- Keep the knees bent and the feet planted on the floor directly under your knees.

START

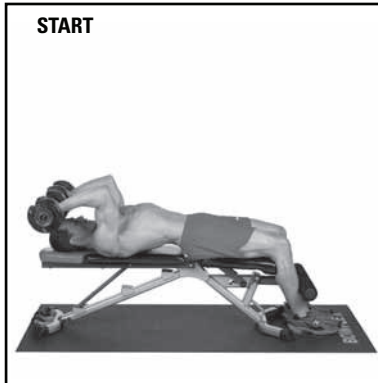

START

- Lie back on the bench with your head supported on the bench.
- Grab the dumbbells and move your upper arm up to a position that your elbow is facing upward and your hands holding the dumbbells are just over your forehead.
- Raise your chest and pinch your shoulder blades together.
- Maintain a very slight arch in the lower back.

FINISH



ACTION

- Keep the upper arms stationary while moving the hands in an arcing motion upward.
- Stop the motion slightly before locking out the elbows. Do not lock out the elbows.
- Slowly reverse the arcing motion back to the starting position.

Hammer Curls

Muscles worked

Biceps, brachioradialis and brachialis



Success tips

- Keep the upper arms motionless and your wrists straight throughout the entire exercise.
- Keep the chest lifted, spine straight, and a slight arch in the low back.

START



START

- Stand with your feet shoulder width apart and knees slightly bent.
- Grab the dumbbells with your palms facing inward toward each other.
- Stabilize the hips, knees and spine.

FINISH



ACTION

- Curl the dumbbells forward, then upward, then in toward the shoulder, keeping the upper arm completely motionless.
- Keep the palms facing in without rotating the lower arm.
- Slowly move back to the starting position.

Single Arm Row — Alternating Rows

Muscles Worked

Latissimus Dorsi, teres minor, posterior deltoid and biceps

Bench position

Flat

Success tips

- Stabilize your body in position so the effort is focused on your lat as you lead the movement with extending your elbow upward.
- Keep the dumbbell lined up directly under your wrist and elbow when doing the movement.
- Keep your spine aligned, abs tight, and a slight arch in your lower back.
- Do not let your spine rotate side to side. Keep the shoulder at equal height during the movement.

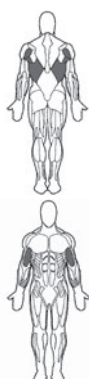

START



FINISH

START

- Put one knee on the bench and place the other foot on the floor directly under your hip.
- Place the free hand on the bench slightly in front of you in a position that allows you to stabilize your upper body.
- Allow the arm with the dumbbell to hang straight down, while maintaining control of your back and shoulder.
- Hold dumbbell in a neutral grip with your palm facing the bench.

ACTION

- Initiate the movement by pinching your shoulder blades back, while simultaneously moving your elbow backward, then upward.
- Continue moving the elbow up, slightly above the height of your trunk while keeping the forearm lined up under the elbow.
- While controlling the resistance, lower the arm back to the starting position letting the shoulder blade slide forward without slouching.

Wide Rows

Muscles worked

Rear deltoid, rear portion of the middle deltoid, posterior rotator cuff, upper lats and teres minor



Success tips

- Place the feet in a comfortable shoulder width position.
- Keep the chest lifted, abs tight and a very slight arch in the lower back.
- Lean forward slightly at the hip while keeping the upper body in alignment.
- Your forearms should always point in the direction of the dumbbells.

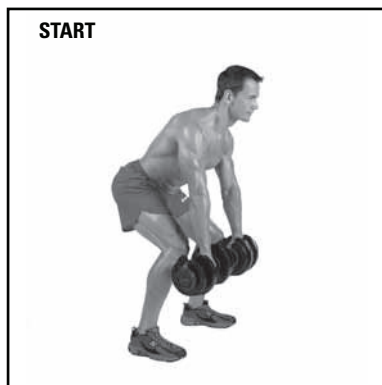

START

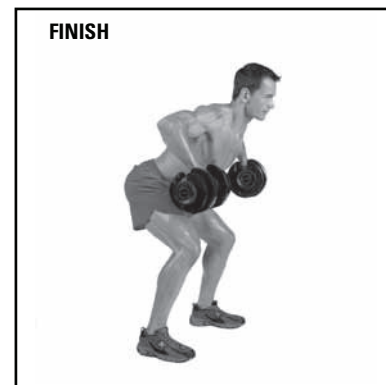

FINISH

START

- While standing holding the dumbbells, lean forward at the hip allowing the arms to extend directly in line with the resistance.
- Keep your spine in a stable position.
- Rotate the shoulder so that your palms are facing behind you.

ACTION

- Allow your arms to bend as you go, move your elbows outward and backward keeping a 70-90 degree angle between your upper arms and your torso.
- Move until your elbows are slightly behind your shoulders, then slowly reverse the action keeping the rear shoulder muscles tightened during the entire motion.

Dead Lifts

Muscles worked

Glutes, adductors, hamstrings, quads, spinal erectors and traps



Success tips

- Keep knees pointed in the same direction as the feet.
- Keep head and neck in line with the trunk.
- Pay close attention to all the alignment and stabilization issues on every part of each repetition.
- Keep pressure through the middle of the arches/feet, not the toes or heels.

START



START

- Position your feet in line with the dumbbell about shoulder width apart.
- Point your toes outward slightly and direct the thighs to the same outward angle as the feet.
- Hold the dumbbells with your palms facing backward.

FINISH



ACTION

- Under control, slowly squat down by sticking the hips out as the knees start to bend.
- Keep the chest lifted and back flat as the hips continue to move backward.
- Lower to approximately a 90-degree bend at the knees, unless otherwise determined.
- Move back to the starting position, keeping the chest lifted while moving the hips forward and extending the knee.

Abdominal Exercises

Ab Crunch

Muscles worked

Rectus abdominus and obliques

Bench position

Flat

Success tips

- Do not lift your head or chin. Your head should follow the rib motion, rather than lead it.
- Maintain normal neck posture.
- Move slowly to eliminate momentum.
- Allow exhalation up and inhalation down, without exaggerating breathing.



START

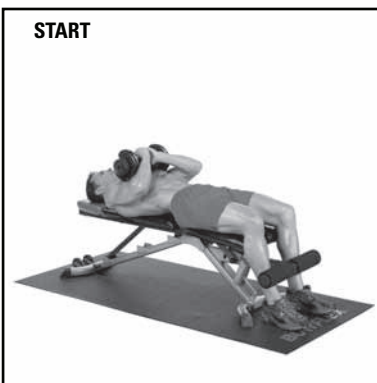

START

- Grab a dumbbell with both hands, as shown.
- Lie flat on the bench holding the dumbbell over your upper chest.
- Place your legs behind the roller pads, as shown, for added support, with your feet flat on the floor.
- Your lower back can start out flat or in a normal arch.

FINISH

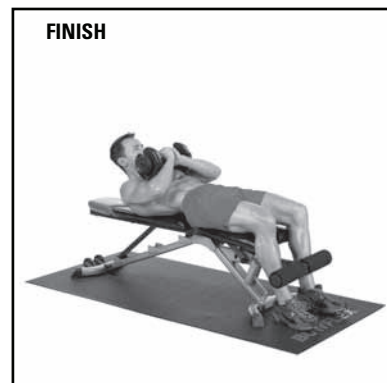

ACTION

- Tighten your abs and only curl your torso, slowly moving your lower ribs toward your hips.
- Move as far as you can without moving the hips and neck.
- The lower back should not lose contact with the bench when fully crunched.
- Slowly reverse the action, returning to the start position keeping tension on the abs throughout the movement.

Reverse Crunch

Muscles worked

Abdominal area, including the rectus abdominus and the obliques

Bench position

Flat

Success tips

- Tighten your abs before you move.
- Keep knees and hips stationary.
- Allow exhalation up and inhalation down, without exaggerating breathing.
- Contract as far into the movements as possible.
- Lower under control.
- The amount of bend in your hips determines the degree of difficulty. Performing the exercise with less bend (so that your knees are farther from your chest) increases the difficulty.
- Beginners should be fully bent, bringing your legs near the abs.



START



START

- Lie on your back with your head resting on the bench.
- Bend your knees fully.
- Note your head and knee positions, and maintain throughout the exercise.
- Reach over the head and grasp the bench with each hand.
- Relax the neck.

FINISH



ACTION

- Tighten your abs and slowly curl your hips toward your rib cage.
- Move as far as you can without using your legs to get momentum, and do not curl up onto your shoulder blades.
- Slowly reverse the action and return to the starting position without relaxing.

Abdominal Exercises

Lying Trunk Rotation

Muscles worked

Deep spinal and trunk muscles

Bench position

Flat

Success tips

- This is an important exercise but can become high risk if done incorrectly.
- Keep the chest lifted and always maintain a good spinal alignment with a very slight arch in the lower back.
- More range of motion is not necessarily better, especially in this exercise.
- Move only as far as your muscles can take you. Try to eliminate uncontrolled momentum.



START



START

- Lie flat on the bench.
- Bend your hips and knees to approximately 90 degrees.
- Keep your chest lifted, abs tight and a slight arch in your low back.
- Hold onto the sides of the bench.

FINISH



ACTION

- Tighten the entire abdominal area and slowly rotate your legs and hips to one side.
- Move slow and controlled, being careful not to let your legs and hips rotate uncontrolled to the side.
- Move back to the starting position.
- Work one side to fatigue and then do the opposite side.

Twisting Side Crunch

Muscles worked

Obliques and rectus abdominus

Bench position

Flat

Success tips

- Allow exhalation up and inhalation down.
- Your head should follow the motion of the rib cage. Maintain normal neck posture.
- Move slowly to eliminate momentum.
- Move as far as you can without moving your hips or neck.



START



START

- Lie back flat on the bench and place one hand behind the head of the involved side.
- Place legs behind the roller pads for added support, as shown.
- Your back can start flat against the bench or in a normal arch.

FINISH



ACTION

- Tighten your abs and move in a diagonal direction, slowly moving your ribs to the opposite hip.
- The lower back should not lose contact with the bench when fully crunched.
- Slowly reverse the motion to the starting position without relaxing the abdominal muscles.

Lying Leg Raise

Muscles worked

Abdominal area, including the rectus abdominus, obliques and quadriceps

Bench position

Flat



Success tips

- Tighten your abs before you move.
- Allow exhalation up and inhalation down, without exaggerating breathing.
- Contract as far into the movements as possible.
- Keep your back flat against the bench.

START



START

- Lie on your back with your head resting on the bench.
- Tighten your abs and flatten your back against the bench.
- Bend your knees and hips to 90 degrees.
- Reach to the side and grasp the bench with each hand.
- Relax the neck.

FINISH

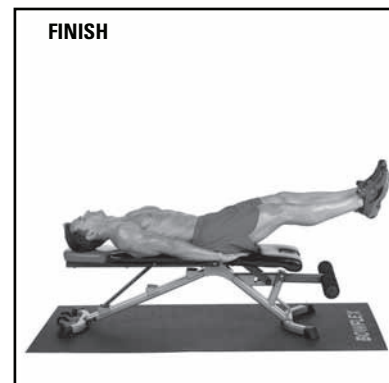

ACTION

- Tighten your abs and slowly extend your hips and knees.
- Move your legs away from you keeping them parallel to the floor.
- Keep your back flat against the bench for the entire movement.
- Slowly reverse the action and return to the starting position without relaxing.

Shoulder Exercises

Standing Shoulder Press

Muscles worked

Front deltoid, upper traps and triceps

Success tips

- Keep knees slightly bent.
- Keep abs tight and a good spinal alignment.
- Do not increase the arch in the lower back as you raise your arms. Keep your spine steady.



START



START

- Grab the dumbbells and stand up straight.
- Keep your chest lifted, abs tight and a slight arch in the lower back.
- Raise the dumbbells to shoulder height, keeping your palms facing forward.
- Upper arms should be 90 degrees away from your torso and your elbows should be bent to 90 degrees, as shown.

FINISH



ACTION

- Straighten your arms slowly over your head, focusing on moving your elbows up and inward toward your ears.
- Slowly return to the starting position, keeping tension on your front shoulder muscles through the entire motion.

Lateral Raise

Muscles worked

Front and middle deltoids

Success tips

- Do not swing the arms upward or move the trunk during the motion.
- Maintain good spinal alignment.

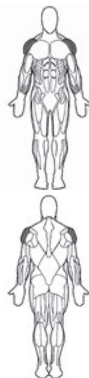

START



START

- Grab the dumbbells with the palms facing each other.
- Stand with your feet slightly wider than shoulder width apart.
- Maintain an erect spinal alignment with the chest lifted, abs tight and a slight curve in the lower back.

FINISH



ACTION

- Raise arms directly outward, then upward, to approximately shoulder height.
- Lift your hand and elbow at the same speed.
- Do not turn or rotate your arms while raising them.
- Keep the side of your arm/elbow facing out/up throughout the movement.

Shoulder Exercises

Seated Overhead Press

Muscles worked

Front deltoid, upper traps and triceps

Success tips

- Keep feet flat on the floor and directly under your knees.
- Keep abs tight and a good spinal alignment.
- Do not increase the arch in the lower back as you raise your arms. Keep your spine steady.



START



START

- Grab the dumbbells and sit up straight.
- Keep your chest lifted, abs tight and a slight arch in the lower back.
- Raise the dumbbells to shoulder height, keeping your palms facing forward.
- Upper arms should be 90 degrees away from your torso and your elbows should be bent to 90 degrees as shown.

FINISH



ACTION

- Straighten your arms slowly over your head, focusing on moving your elbows up and inward toward your ears.
- Slowly return to the starting position, keeping tension on your front shoulder muscles through the entire motion.

Front Raise

Muscles worked

Front deltoid

Success tips

- Keep knees slightly bent.
- Keep abs tight and a good spinal alignment.
- Do not increase the arch in the lower back as you raise your arms. Keep your spine steady.



START

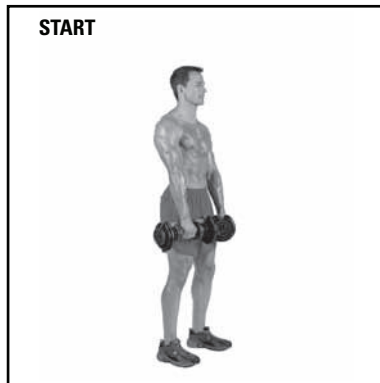

START

- Grab the dumbbells and stand up straight.
- Feet should be approximately shoulder width apart.
- Keep your chest lifted, abs tight and a slight arch in the lower back.
- Hold the dumbbells in front of you with your palms facing back.

FINISH



ACTION

- Keep the arms straight and the palms facing down, move your arms forward and then upward to shoulder height.
- Slowly return to the starting position, keeping tension on your front shoulder muscles through the entire motion.

Shoulder Exercises

Rear Delt Row

Muscles worked

Back of the middle deltoid, the rear deltoid, posterior rotator cuff, trapezius and rhomboids.



Success tips

- Keep your spine and hips stable and do not allow your body to sway during the motion.
- For normal pulling exercises you may choose to let the shoulder blades float forward and backward naturally. However, for more emphasis to the rear deltoid, keep the shoulder blades pinched together throughout the movement.
- Keep your abs tight, chest lifted and maintain a slight arch in your lower back.

START

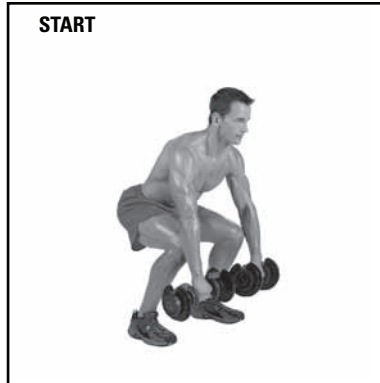

START

- Stand with your feet approximately shoulder width apart.
- Grab the dumbbells with your palms facing back.
- Bend forward at the knees and hips so that your arms will hang slightly in front of your knees holding the dumbbells.
- Keep your head/neck in line with your spine, as shown.

FINISH

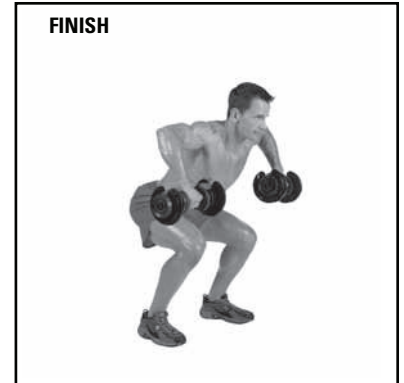

ACTION

- Allow your arms to bend as you move your elbows upward keeping a 60-80 degree angle between your arms and your torso.
- Your forearms should always point in the direction of the dumbbells.
- Move till your elbows are slightly behind your shoulders, then slowly reverse the motion, keeping tension on the rear shoulder muscles during the entire motion.

Shrugs

Muscles worked

Upper trapezius



Success tips

- Do not bend the neck backward or forward while raising the shoulders.
- Keep abs tight and a good spinal alignment.
- Make sure both shoulders are raised evenly.

START

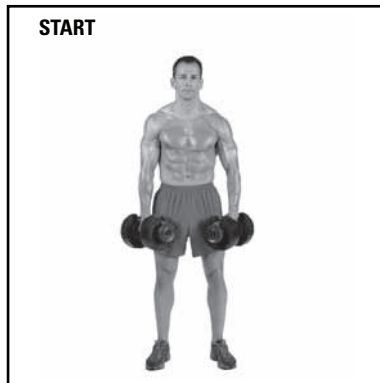

START

- Grab the dumbbells and stand up straight.
- Feet should be approximately shoulder width apart.
- Keep your chest lifted, abs tight and a slight arch in the lower back.
- Hold the dumbbells naturally to your sides.

FINISH

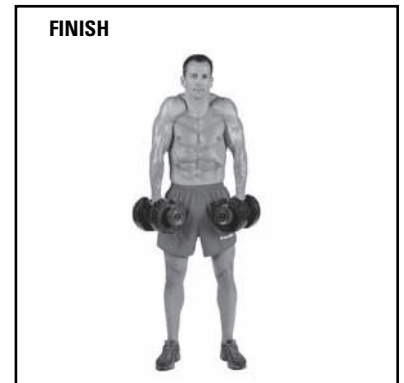

ACTION

- Raise your shoulders toward the back of your head, making sure your neck/head position does not move.
- Slowly return the shoulders to the starting position, keeping tension on your upper shoulder and neck muscles through the entire motion without slouching or rounding your upper spine.

Muscle Chart

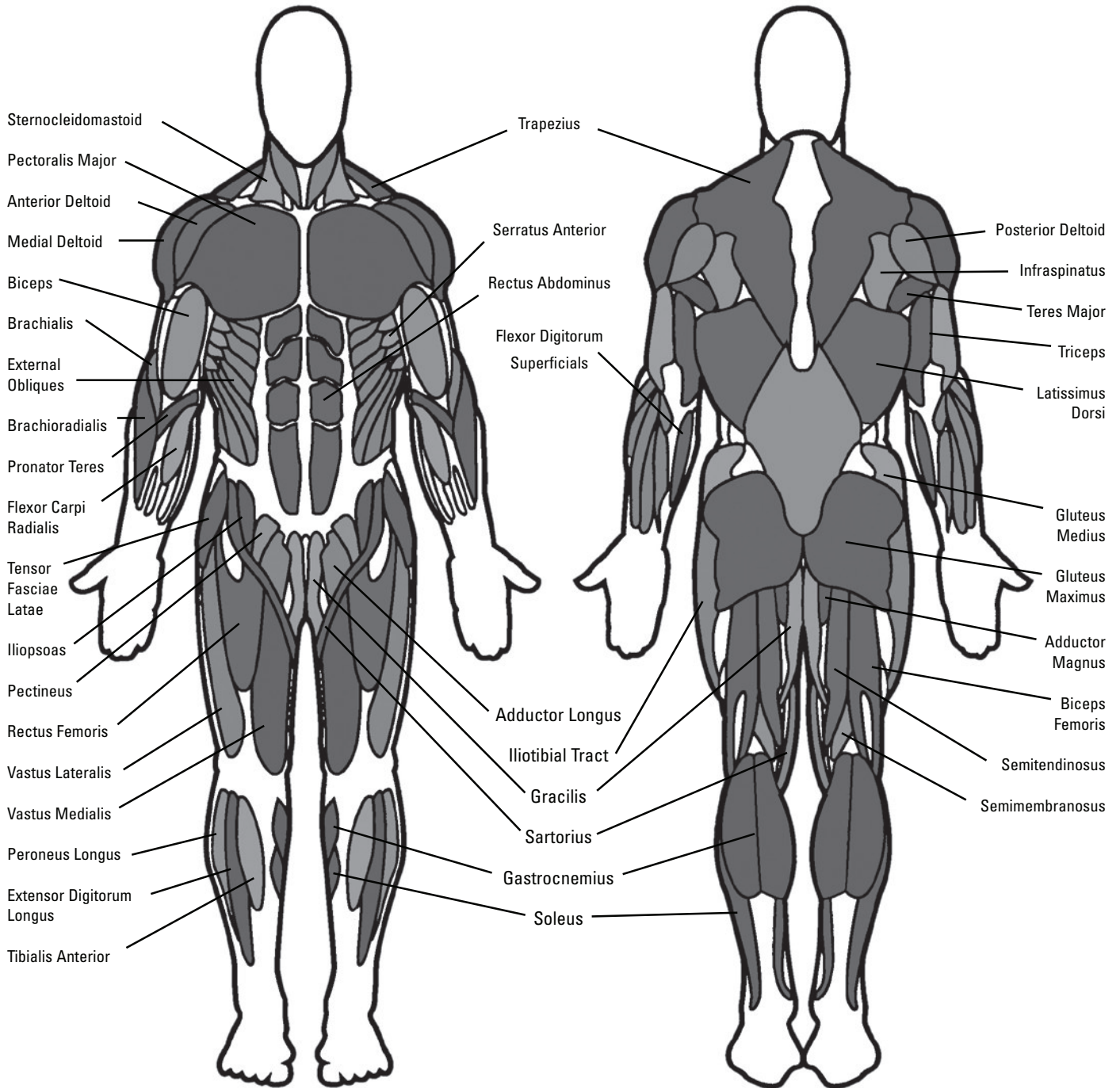

This page intentionally left blank.

BOWFLEX[®]